

ART 2640, Building Systems of Interior Environments

Fall Semester 2020

Tuesdays & Thursdays 10:30-11:50

Online

Matthew Ziff, Associate Professor, Area Chair

M. Arch, Architect, NCIDQ

Office: W 325 Grover Center

Office hours: MW: 10:45 - 11:35 TTH: 12-1

Telephone: 740. 593. 2869

E-mail: ziff@ohio.edu

Plumbing, Electricity, Elevators, Stairs

Electricity



- Electricity is a form of energy.
- Electricity is the flow of electrons.
- We get electricity, which is a secondary energy source, from the conversion of other sources of energy, like coal, natural gas, oil, nuclear power and other natural sources, which are called primary sources.
- Many cities and towns were originally built alongside waterfalls (a primary source of mechanical energy) that turned water wheels to perform work.

- Before electricity generation began slightly over 100 years ago, houses were lit with kerosene lamps, food was cooled in iceboxes, and rooms were warmed by wood-burning or coal-burning stoves.
- Beginning with Benjamin Franklin's experiment with a kite one stormy night in Philadelphia, the principles of electricity gradually became understood.
- In the mid-1800s, life changed dramatically with the invention of the electric light bulb.

- To solve the problem of sending electricity over long distances, George Westinghouse developed a device called a transformer.
- The transformer allowed electricity to be efficiently transmitted over long distances.
- This made it possible to supply electricity to homes and businesses located far from the electric generating plant.

- An electric generator is a device for converting mechanical energy into electrical energy.
-
- The process is based on the relationship between magnetism and electricity.
- When a wire or any other electrically conductive material moves across a magnetic field, an electric current occurs in the wire.

- A magnet attached to the end of a rotating shaft is positioned inside a stationary conducting ring that is wrapped with a long, continuous piece of wire.
- When the magnet rotates, it induces a small electric current in each section of wire as it passes.
- Each section of wire constitutes a small, separate electric conductor.
- All the small currents of individual sections add up to one current of considerable size.

- Most of the electricity in the United States is produced in steam turbines.
- A turbine converts the kinetic energy of a moving fluid (liquid or gas) to mechanical energy.
- Steam turbines have a series of blades mounted on a shaft against which steam is forced, thus rotating the shaft connected to the generator.
- In a fossil-fueled steam turbine, the fuel is burned in a furnace to heat water in a boiler to produce steam.

“Building Systems For Interior Designers” by C. Binggelli.

- Be sure to read pages 213 – 265 of “Building Systems For Interior Designers” by C. Binggelli.
- These pages will be the source of some questions on the mid-term exam.

Electricity is made as Direct Current (DC) Alternating Current (AC)

- Direct Current (DC)

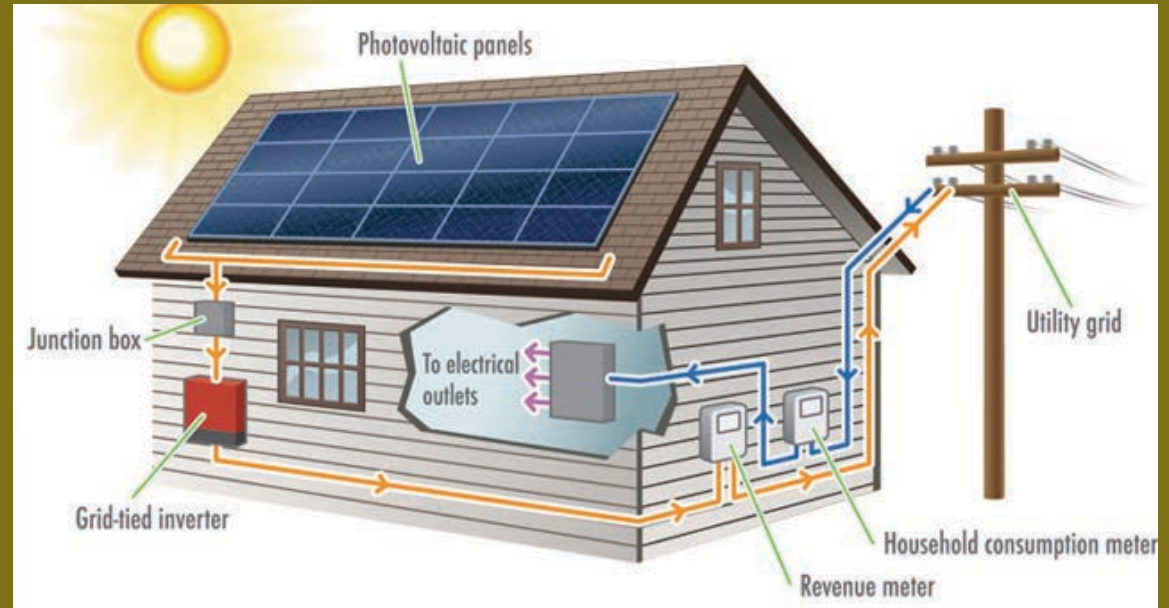



Direct Current



Alternating Current

Direct Current (DC)

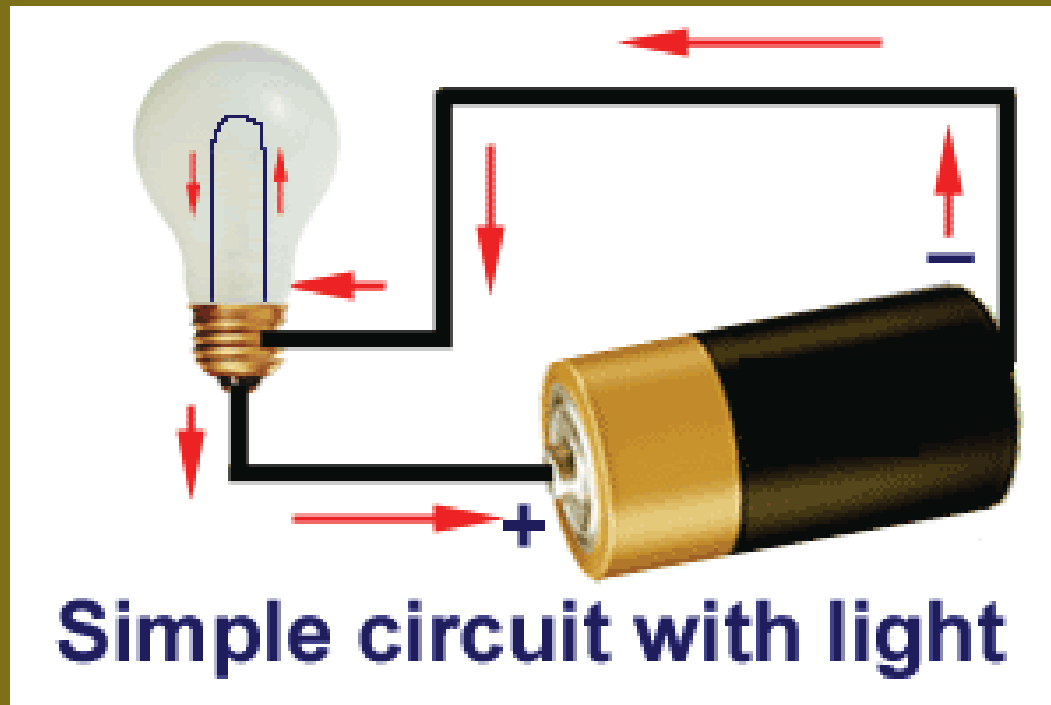

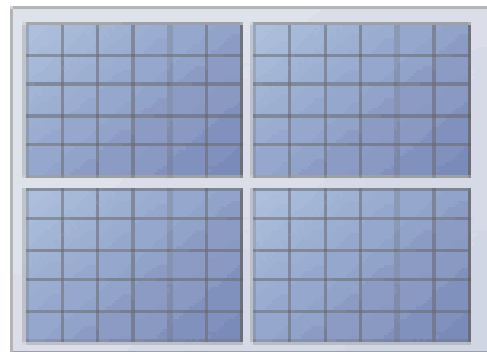

Solar panel

DC

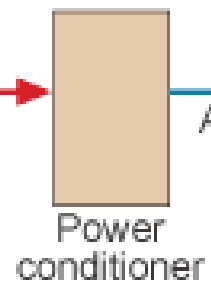

Power conditioner

AC

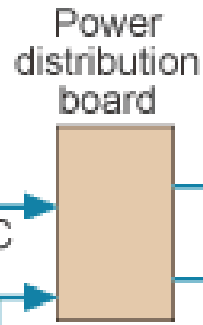

Power distribution board



Electric company

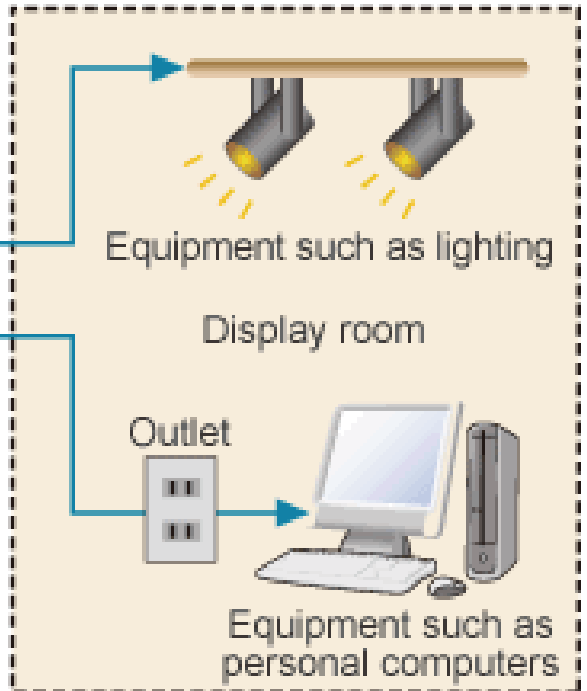

Equipment such as lighting

Display room

Outlet

Equipment such as personal computers

Direct Current can be transformed using an Inverter to become Alternating Current

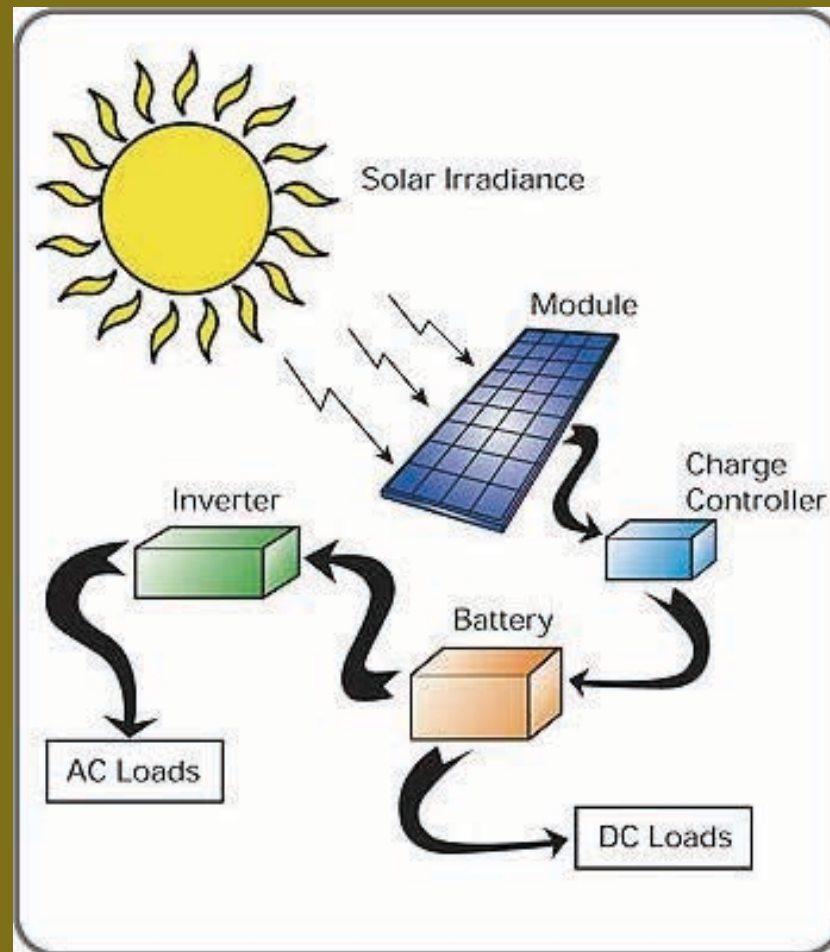

Alternating current examples

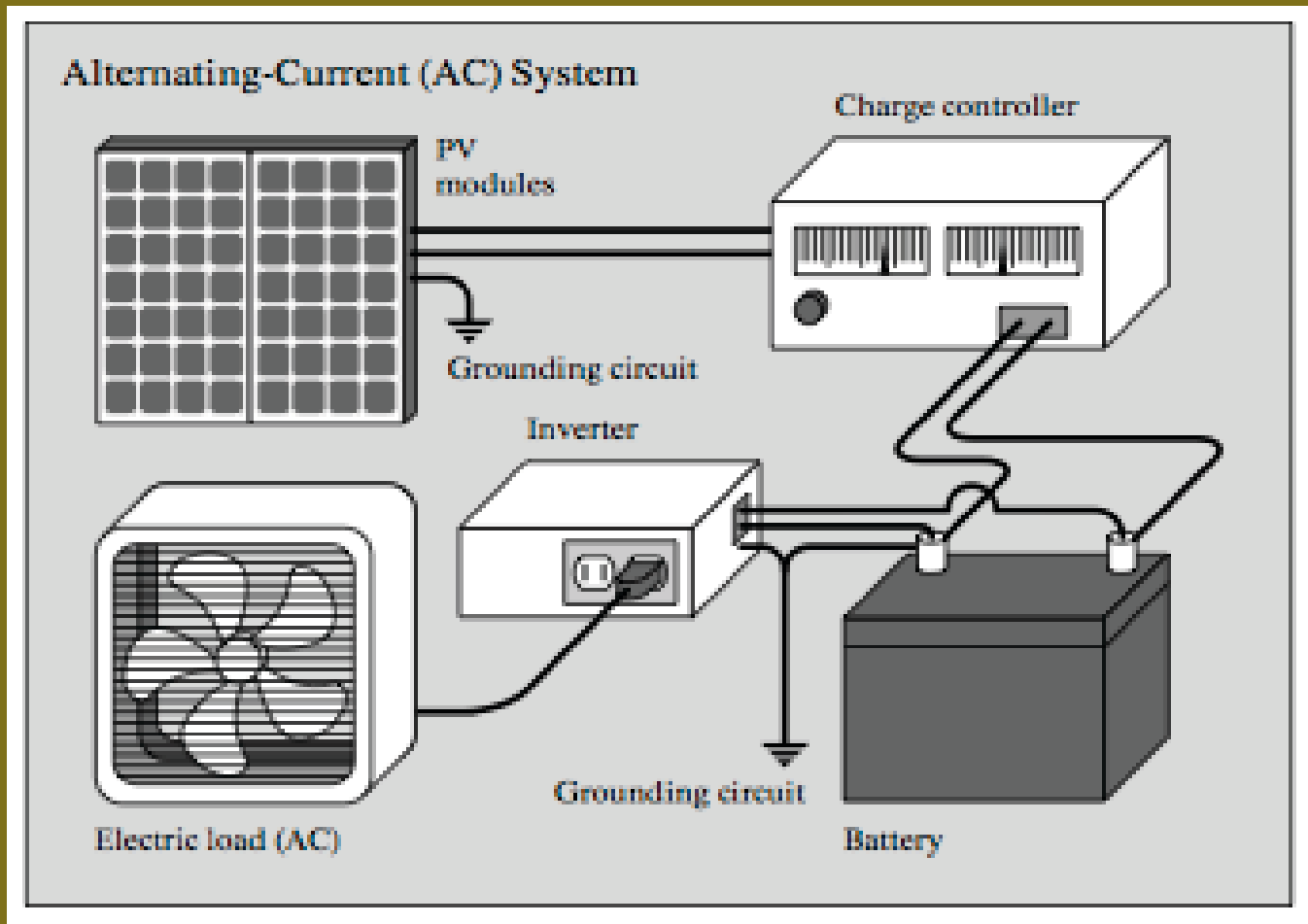

Electricity: we can create it, control it, and use it.



In large buildings electricity is the most used form of energy.

Lighting and the motors used to power HVAC and other mechanical equipment are the two major users of electricity in these buildings.



An electric current runs through the filament inside this partial vacuum bulb and glows white from the heat created by the friction of resistance.



Lightning is a naturally occurring form of electricity



Electric use around the world

Household Electricity Use

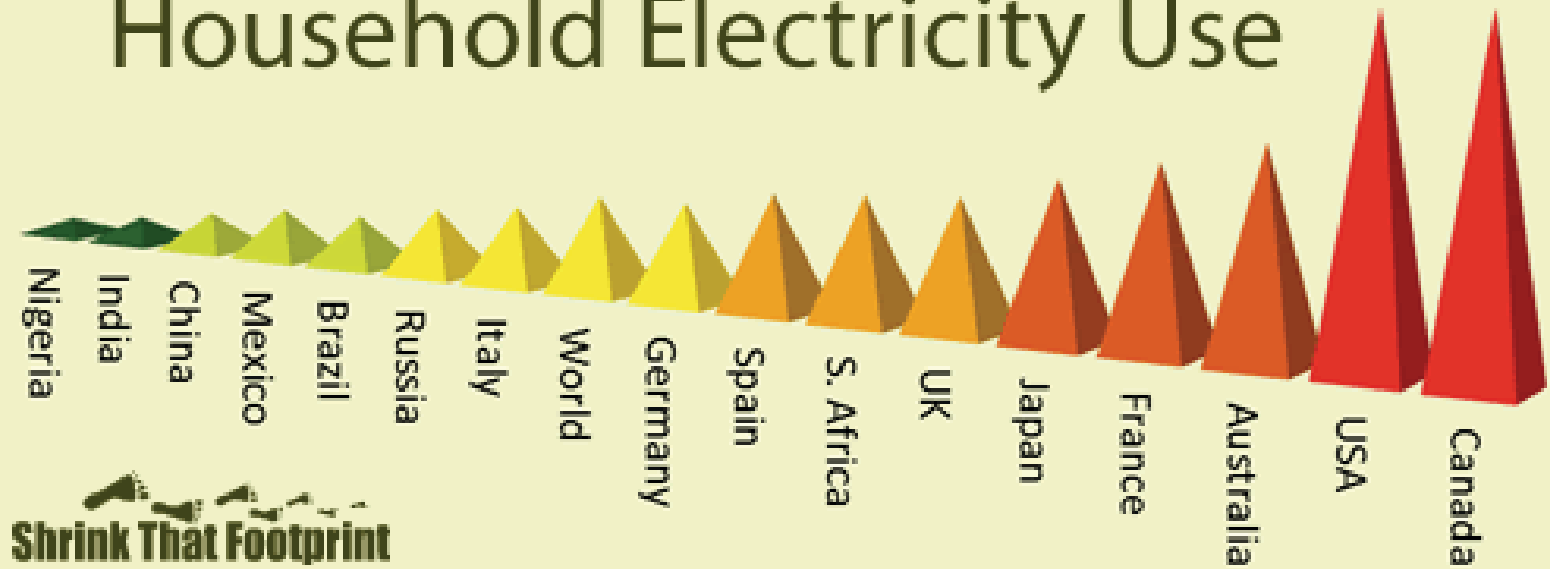

Very high voltage power lines



A transformer steps down the high voltage coming from the power company to a lower, useable, level for buildings.



Wind turbines



The wind turbine is still dangerous for birds



U.S. energy consumption by energy source 2012

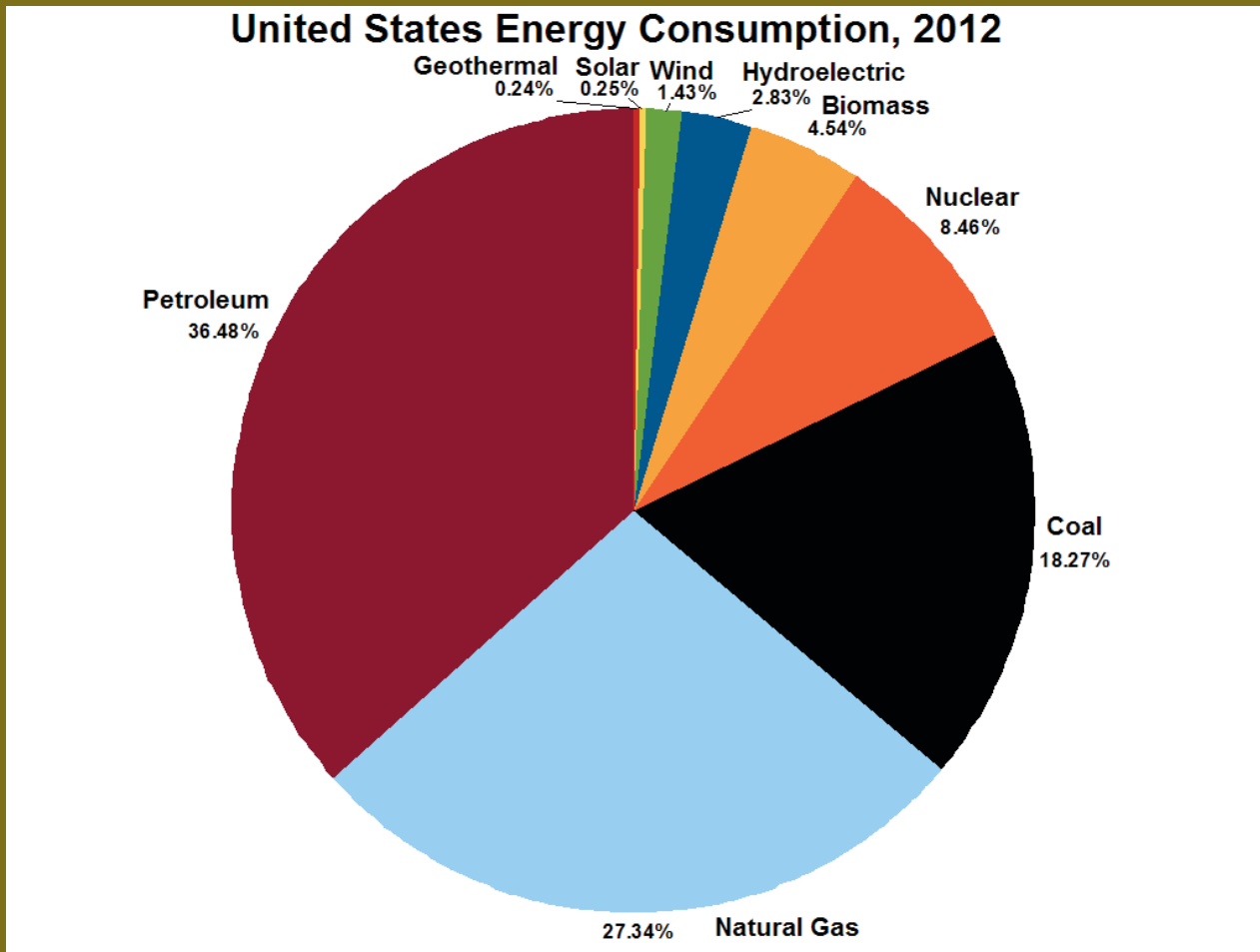

U.S. energy consumption by energy source 2015

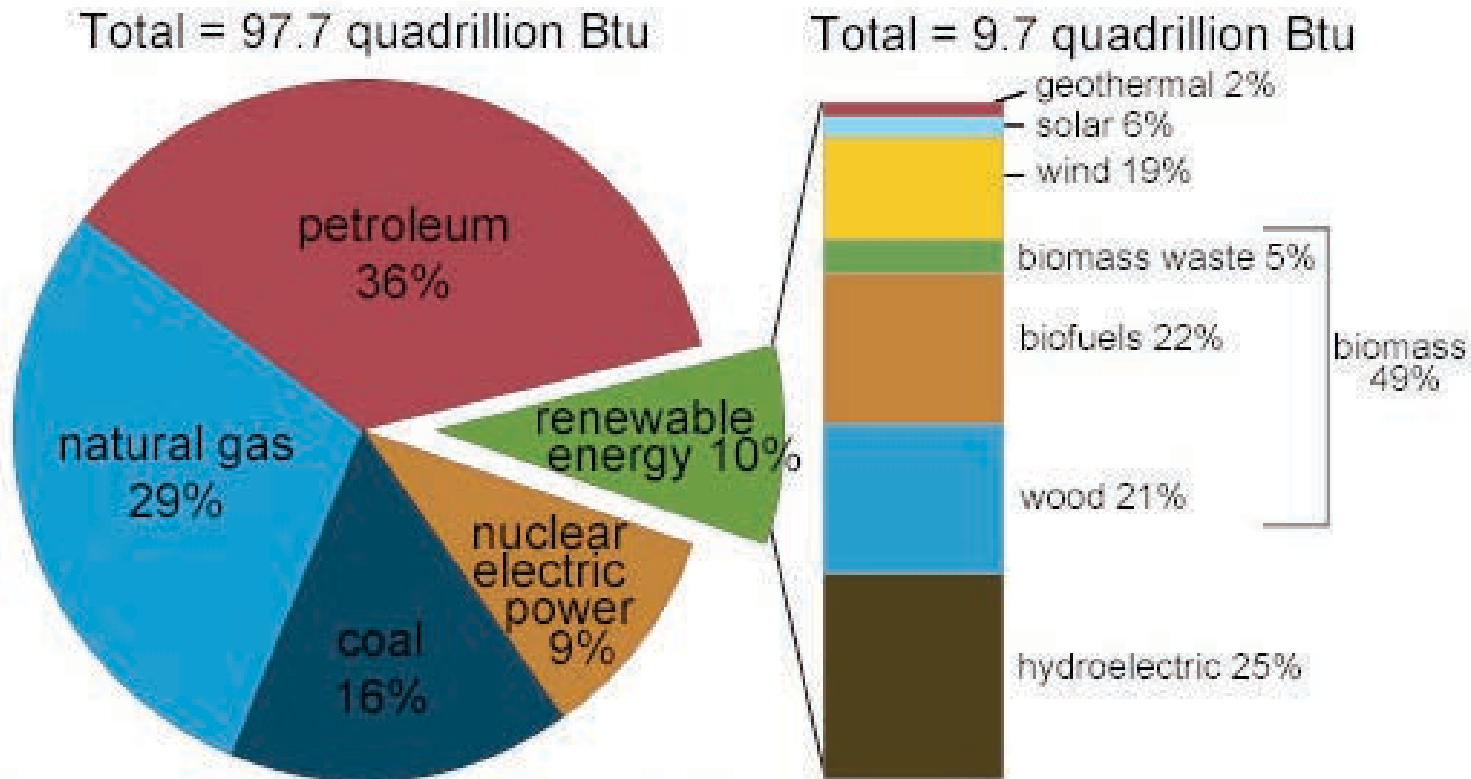

Note: Sum of components may not equal 100% because of independent rounding.

volts, amperes (amps), watts:

these are the terms used to discuss aspects of electricity.

the full, scientifically complete, meaning of these terms is very complex.

How Electricity Works

for a good explanation of the complexities of electricity, look through this pdf document.



The generation of electricity is most commonly achieved by converting *chemical* energy in fuels or the *flowing* energy of wind, water, or steam into *electrical* energy, using a mechanical turbine connected to a generator.

The force of the fluid causes the turbine to rotate, which in turn rotates the magnetic field inside the generator to produce electricity.

[How Hydro Electric Power Plants Work](#)

How Electricity is 'made'

Typically, a fuel such as coal or oil is burned in a boiler to produce steam.

The chemical energy in the fuel becomes heat energy as it burns, forming hot gases.

The steam, under great pressure, rushes through pipes and valves and turns the steam turbine at high speed.

The turbine is made up of blades on a shaft and is driven by the steam like wind drives a windmill.

'Volts' is used to describe the measure of "electrical pressure" that causes current flow. (for example, typical residential electric lines have 110 volts)

'Amperes' (amps) is used to describe the amount of electricity in a circuit. (a typical circuit in a house is described as being 30 amp, or 20 amp, which is a description of how much current there is in the circuit)

'Watts' is the term used to describe the power used by a circuit. (for example, a light bulb may use 100 watts of power to generate the level of light that it produces.)

Electric wiring, and electric components impact the design of interiors by:

requiring space: wires, conduit, and fixtures take up space; hidden inside walls, floors, and ceilings, or exposed to view.

requiring coordination: between designers and electrical engineers.

adding heat to the space: many commercial environments always require cooling because of internal heat generated by occupants, electric fixtures and machines.

How electric components impact interior design

- Estimate the total electric power consumption of the project spaces.
- Plan support spaces: electric closets, transformer rooms, and conduit **chases**.

- Identify the various electric uses:
- high voltage needs?
- under floor wiring? above ceiling?
- extent of lighting
- data cables, security systems, other electric devices
- lighting fixtures, appliances, equipment, emergency electrical systems all affect interior design.

Electricity in most urban locations arrives at a building from a power company's network

- Company power lines to the building
- Electric meter at the point the line connects to the building
- Circuit panel (box) inside the owner occupied space
- Wiring throughout the interior/occupied spaces
- Outlets to allow access to the building electricity
- Devices: appliances, motors, lighting, computers, et cetera

A circuit box/ panel board is used to distribute the electricity to spaces within the building/house



Each circuit connects to a specific location in the building.
Each circuit is rated in amperes (amps)

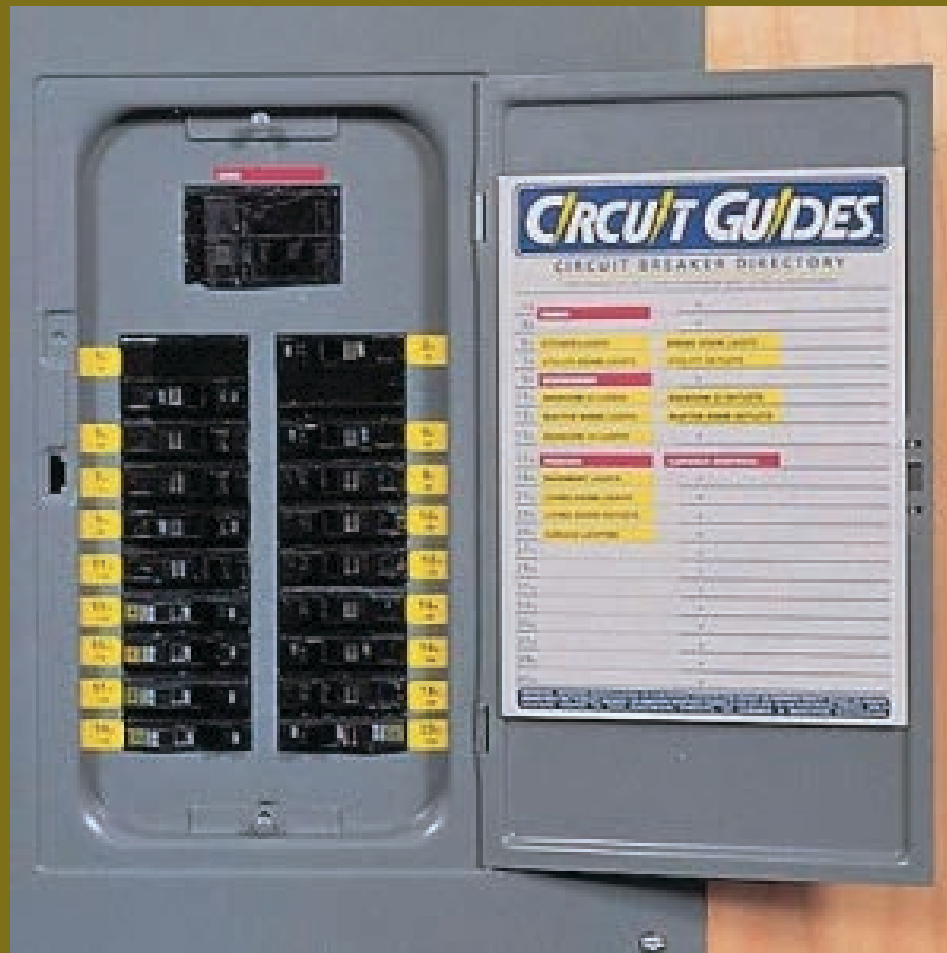

Wiring runs from the circuit box to all of the electric outlets in the building.



Individual circuits connect to the bus bar, which is connected to the incoming power line.

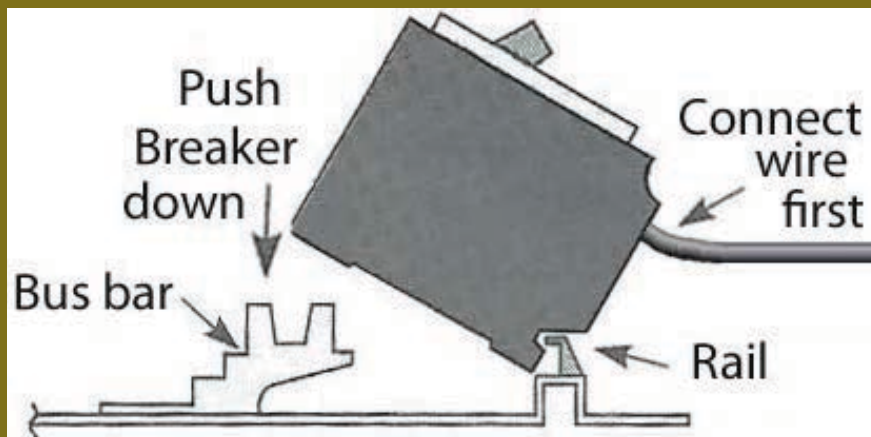
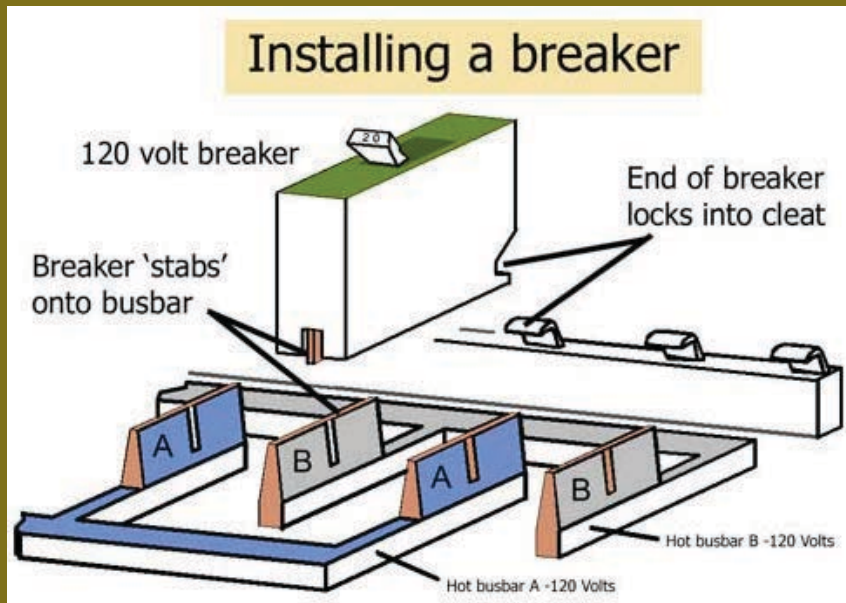

Ground Fault Circuit Interrupters (GFCI)

- Protection against shocks when it instantaneously detects misdirected electric current. Small ground faults, leaks in the electric system.

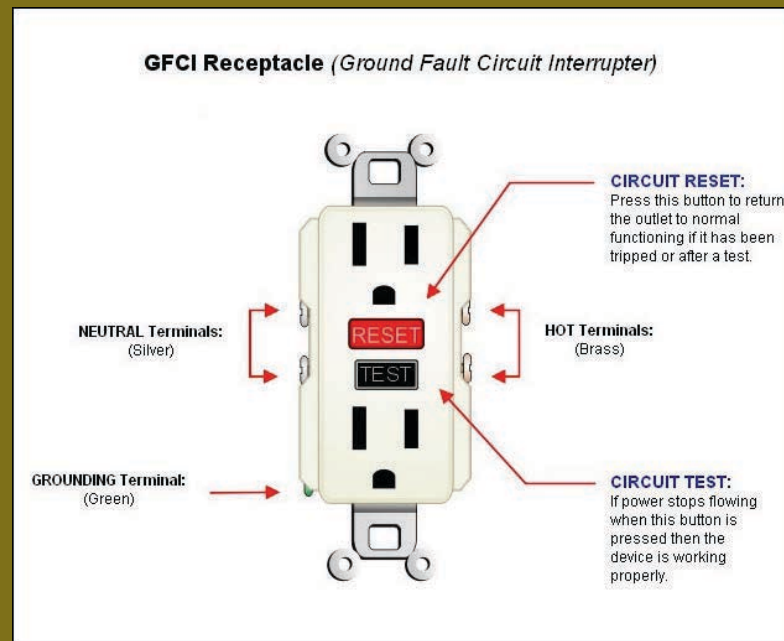

Plumbing Systems

- Pages 31 – 79 of “Building Systems for Interior Designers” by Corky Binggelli is the reference for this section of the course.

The total amount of water on Earth is finite and it is the same water that has been here for millions of years.

- Clean water is expensive.
- Many parts of the earth experience extreme water shortages.
- To assure a level of sanitation, of cleanliness, in our municipal water supply, all water is treated with purification processes.
- [How Plumbing Systems Work](#)

Water Scarcity today

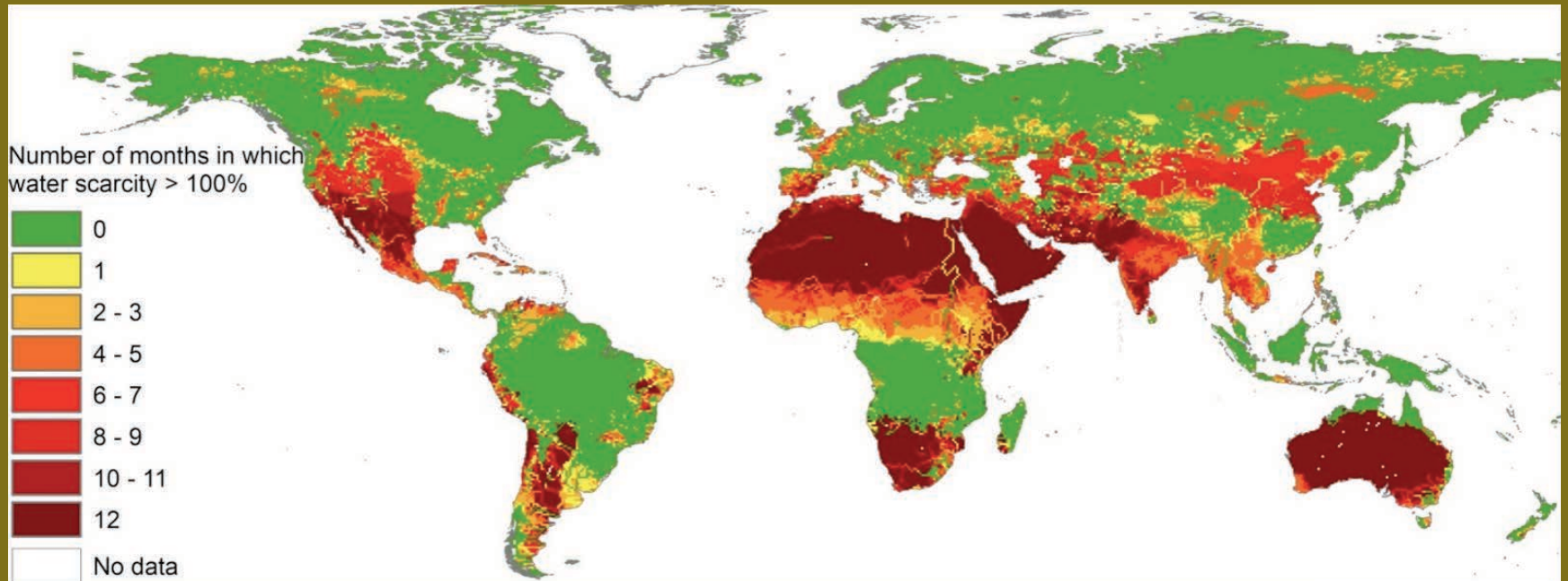

The threat of water scarcity looms large



Plumbing Systems

Supply-Drain&Vent-Sewer

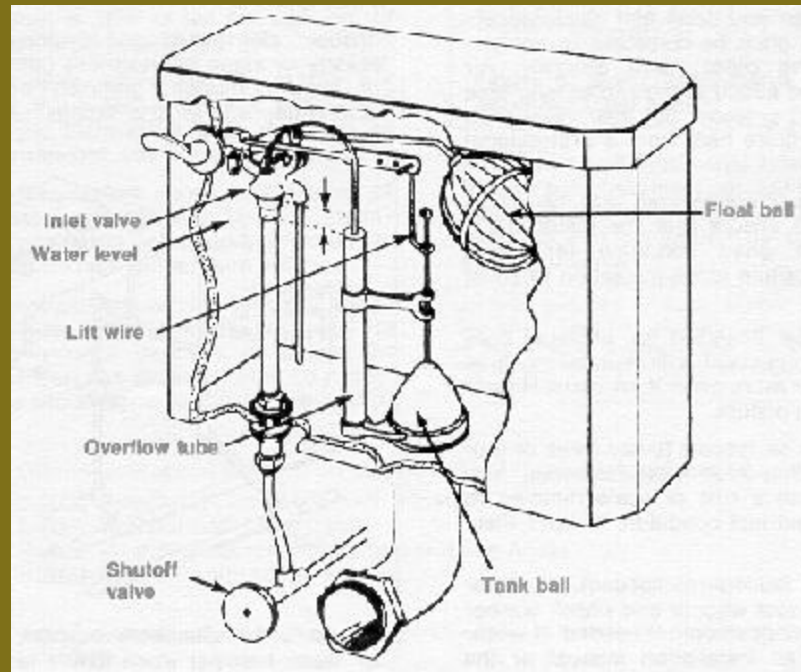
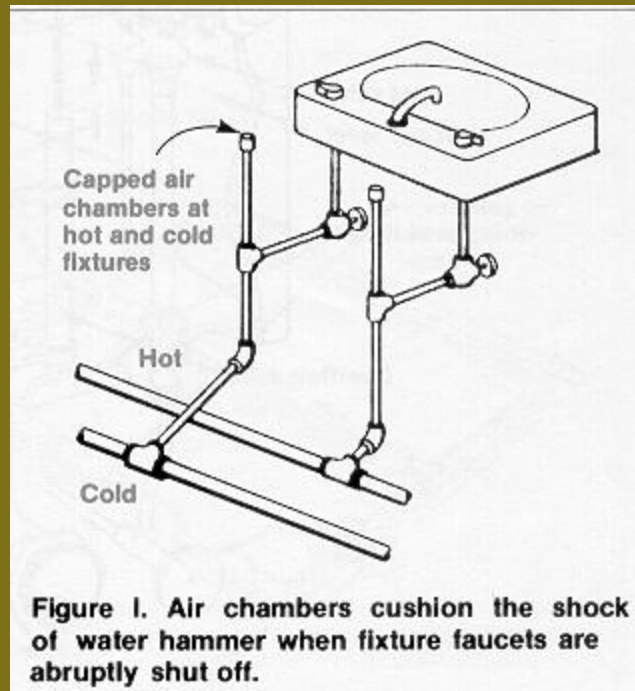

Vents are critical to the working of a plumbing system

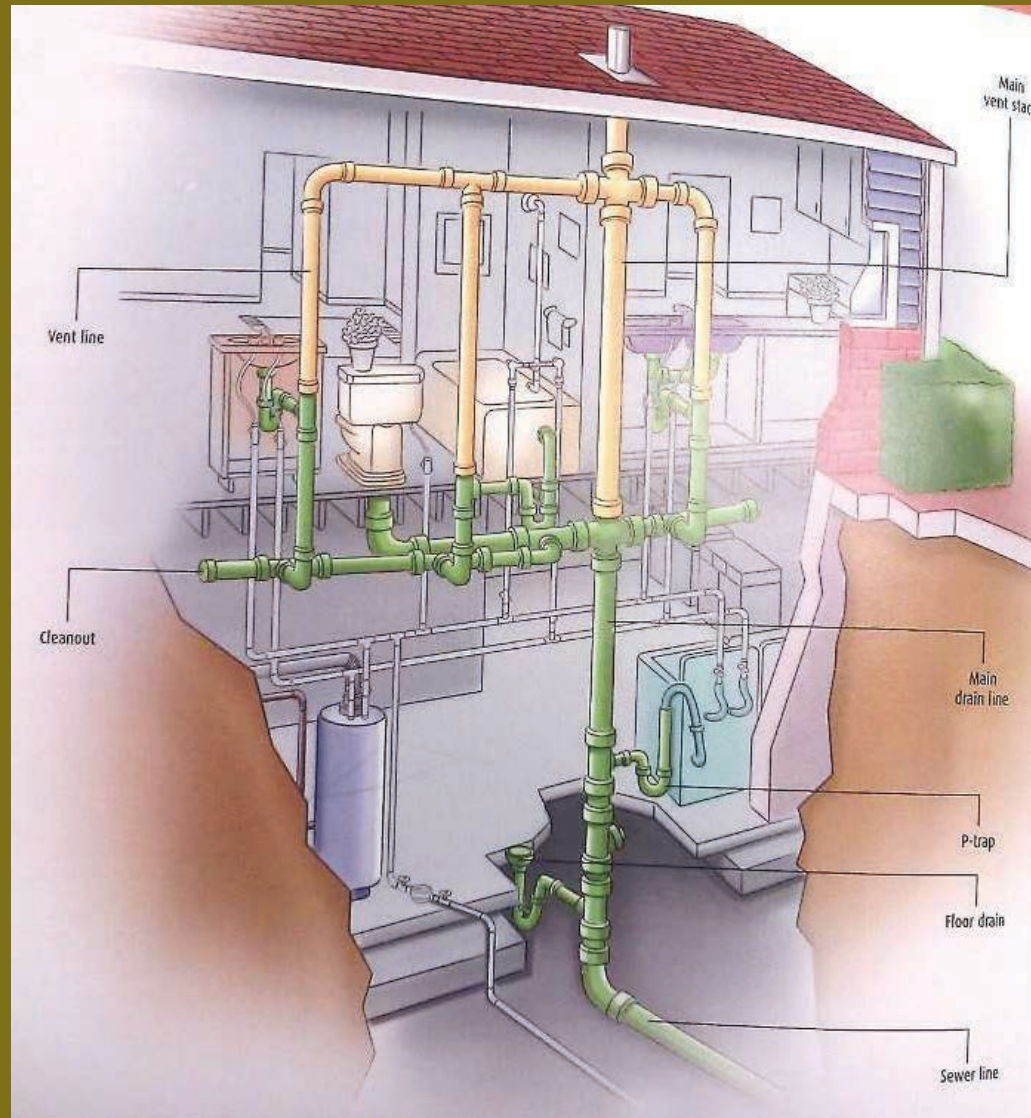

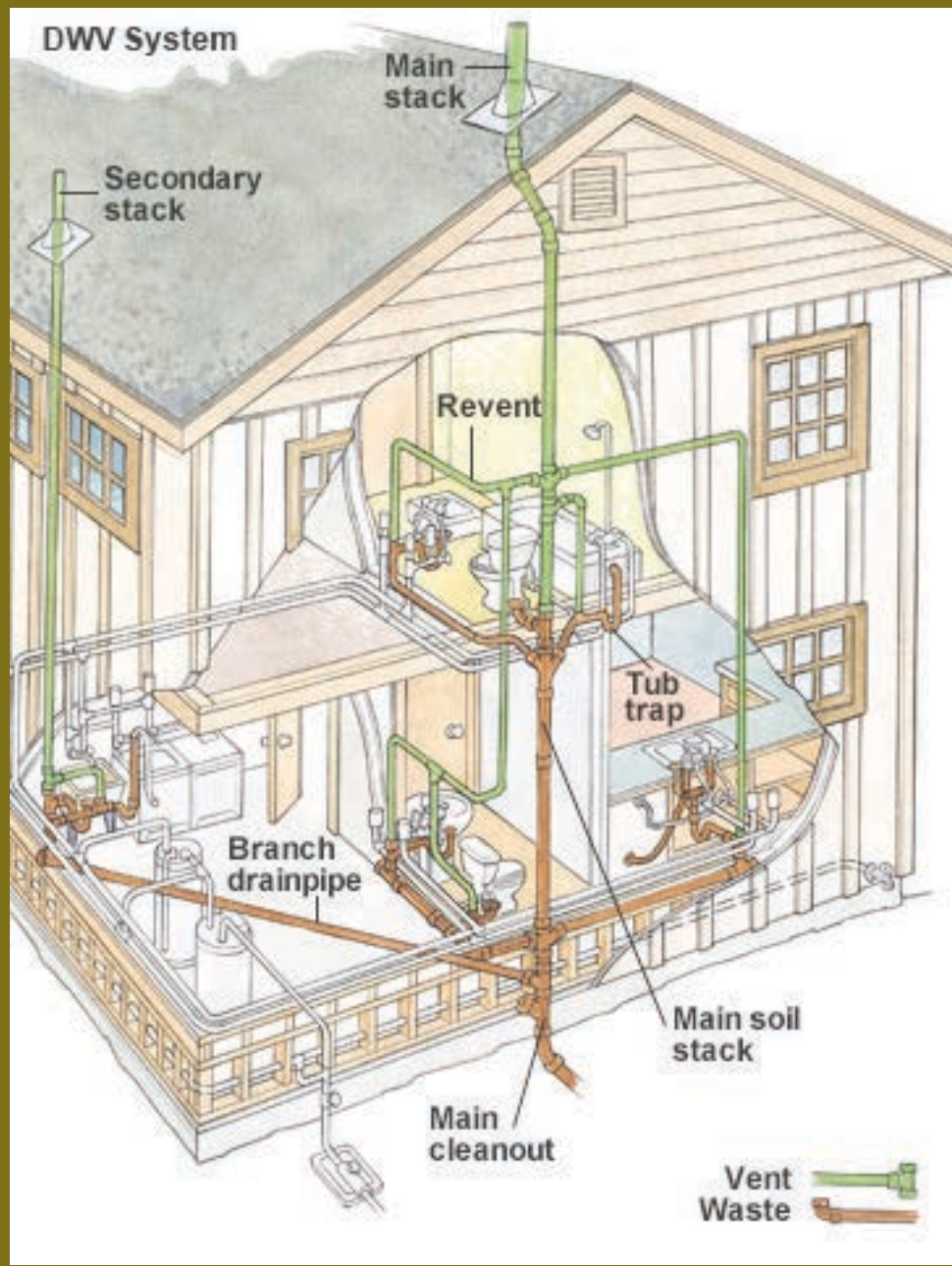

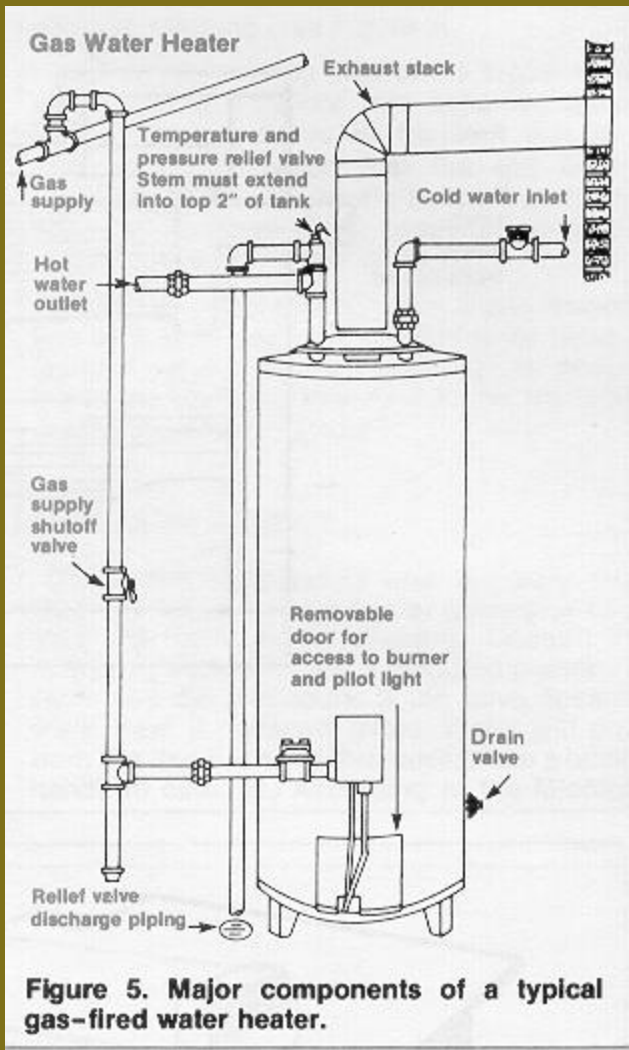

Commercial, big building, heating system

Residential hot water heater

Plumbing systems include supply lines, drain lines, water heaters, valves, filters, and other equipment

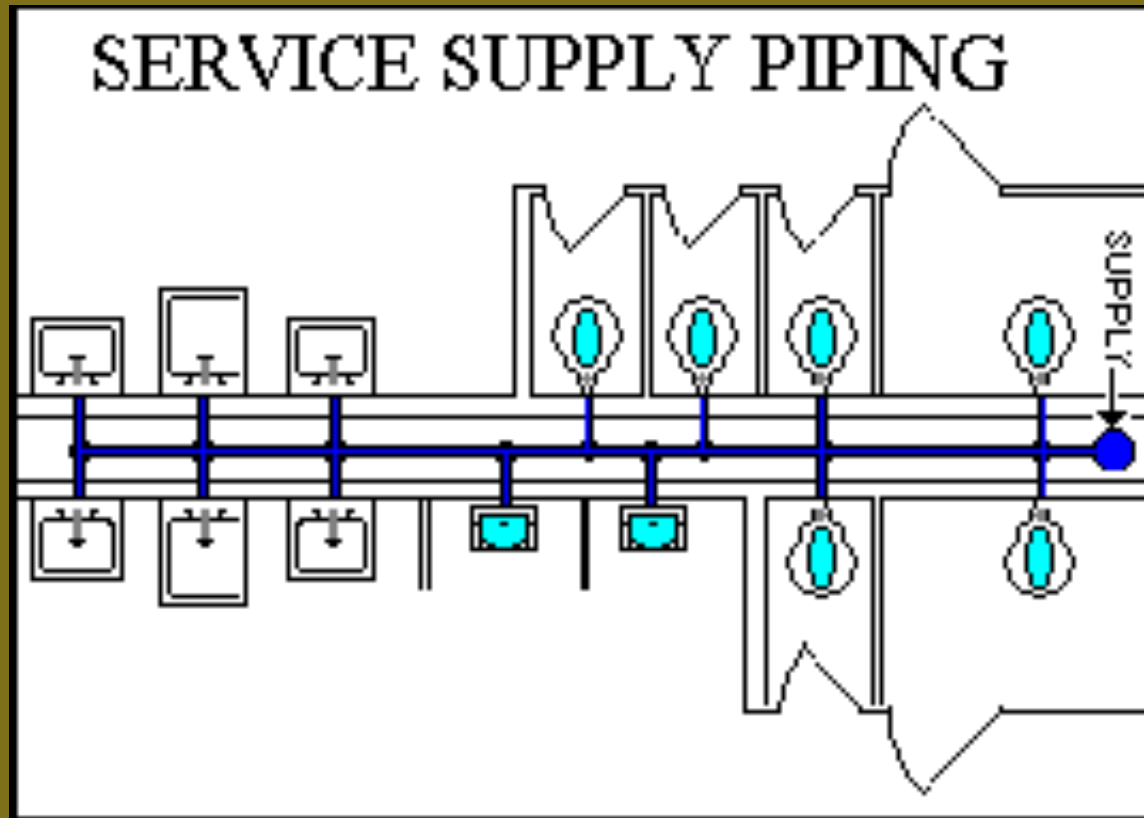

between supply and drain lines there is a drain, and air lock, trap, device



plumbing pipes are made of:
copper, pvc, cast iron, and occasionally brass



a typical residential plumbing layout

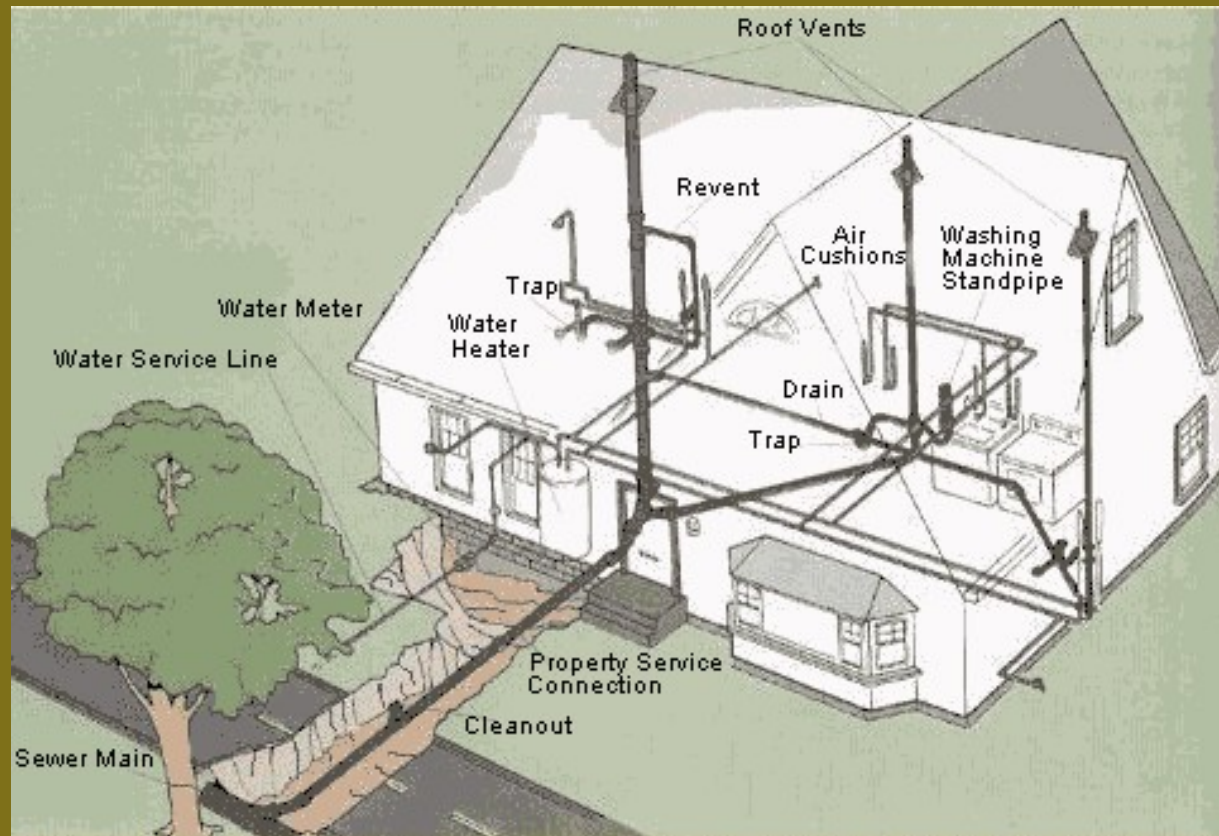

good quality fixtures are made of
brass, with chrome plating



Kitchen Sink - 20w x 30l x 10d - weathered copper



The design and manufacture of kitchen and bath components is, today, better than ever before.

Components are available that are designed and produced at high quality levels.

Look through a good design magazine, such as Domus, Dwell, Metropolis, and you will see many interesting variations of sinks, toilets, ovens, stoves, and refrigerators.

Why should interior designers care about plumbing fixtures?



Kraus faucets



Grohe faucets



HPB BATHROOM IS A GLOBAL POSITIONING HIGH END BATHROOM HARDWARE MANUFACTURERS. HAS A STRONG R&D DEPARTMENT AND PRODUCT DEVELOPMENT TEAM. AND MANY SUCCESSFUL BUSINESS TIES WITH MANY SANITARY WARE BRAND IN GERMANY. THE 12 YEAR HISTORY OF THE DEVELOPMENT OF THE BUSINESS HAS OBTAINED MANY TECHNOLOGY PATENTS IN 2013.ATS CERTIFIED BY EUROPE'S HIGHEST LEVEL. THE COMPANY IS HERE TO THE MOST ADVANCED R&D AND PRODUCTION TO ENSURE THE QUALITY OF ALL STANDARDS.



Bathroom faucet by Cavell



Bathroom faucet by Elite



Bathroom faucet by Delta
this faucet does meet ADA requirements, and is well made,
but is, in my aesthetic sensibility really ugly!



Not ADA compliant, not easy to operate, poorly manufactured.



Not ADA compliant, not easy to operate, poorly manufactured.



Purpose of Building Codes

- The purpose of Building Codes is to provide minimum standards to safeguard life or limb, health, property, and public welfare by regulating and controlling the design, construction, quality of materials, use and occupancy, location and maintenance of all buildings, structures and certain equipment within this jurisdiction.

Electric Code Requirements

- The purpose of electric codes is the practical safeguarding of persons and property from hazards arising from the use of electricity.
- Residential codes require that every room, hallway, stairway, attached garage, and outdoor entrance must have a minimum of one lighting outlet controlled by a wall switch.

Stair Design: General Guidelines International Building Code (IBC)

- Stair riser heights shall be 7 inches (178 mm) maximum and 4 inches (102mm) minimum.
- Stair tread depths shall be 11 inches (279 mm) minimum.
- Winder treads shall have a minimum tread depth of 11 inches (279 mm) measured at a right angle to the tread's leading edge at a point 12 inches (305 mm) from the side where the treads are narrower and a minimum tread depth of 10 inches (254 mm).
- [International Building Code for Stair treads and risers](#)

Stair Design: General Guidelines

no more than 3/16" variation between successive risers and treads

residential stairs:

minimum width = 36"

maximum riser height = $7 \frac{3}{4}$ "

minimum tread depth = 10"

minimum headroom = 6'-8"

non residential stairs:

minimum width = 44" (this is two 'exit units' of 22" each)

minimum height of riser= 4"

maximum riser height = 7"

minimum tread depth = 11"

minimum headroom = 6'-8"

maximum distance of travel of 12' in vertical distance without a landing. any stair going more than 12' vertically must have a landing.

stairways must have a landing at the top, bottom, and at changes of direction in a stair.

Handrails

handrails must be on both sides of a stair

handrails are to be between 34"-38" above the stair-tread nosing

handrails are to be a minimum of 1 1/2" from the wall/mounting surface to allow for grasping

outdoor stairs, or monumental stairs do not have to adhere to the riser and tread requirements of egress stairs.

the width of an exit stair is calculated in terms of 'exit units' which are 22" units, based on the idea that one person is approximately 22" wide.

Ramps

ramps are to be no steeper than 1:12

a ramp may not be longer than 30' without a level landing

ramps are limited to a vertical rise of 30" between landings

the width of ramps shall not be less than the width of exit corridors: a minimum of 44" (2 exit units)

Stair calculation:

the number of risers and treads in a run of stairs

to calculate the number and size of steps in a run of stairs:

identify the required height, from finished floor, to finished floor

divide this height by the approximate height of the riser of one step

since there can be no partial steps, round off any non-whole numbers and divide the rounded number into the height of the run of the stairs.

this number is the accurate size of one riser, to the nearest tenth of an inch.

Let's say that we need a stair to go from the first floor of Cutler Hall, to the second floor.

The distance, from the first floor finished surface, to the second floor, finished floor surface is to be 13'-7".

How many risers and treads are needed to make a legal stairway here?

First convert the vertical distance to be covered by the stair to inches:

$$13'-7" = 163"$$

Assume 7" as a beginning size for a riser

$$163 \text{ divided by } 7 = 23.28$$

Now, we know that you cannot have 23.28 risers; risers must be a whole number.

We could take 23 as a total riser number, which would produce a riser that is greater than 7", which is not allowed by code, so we will take 24 as a total riser number.

So, take 24, and divide 163 by 24, which is 6.7916": this is the height of each riser, in the run of 24 that makes this stairway.

So, to determine the number, and height of the risers in a stairway, take the total height of the stairway, in inches, and divide it by 7" as a way to determine a close number of risers. (if this comes out to a whole number, then you are done)

Then take the total height in inches, and divide it by the number of risers to arrive at a precise riser height dimension.

In construction tolerances vary:
factory made=more precision
job site made= less precision

- In terms of construction, a stairway can be manufactured with varying levels of precision.
- If the stairway is a factory made, steel construction, then the precise dimension of the riser height can be very accurate, to a sixteenth of an inch even.

Construction Tolerance

- If the stairway is to be constructed on the job site, and especially if it is to be made of wood, then the sizes cannot be held to a tolerance any more precise than 1/8".

A spiraling stair



An 'open riser' stair

In the U.S. open risers are limited to a maximum of 4"



Open riser stair



Creative use of space beneath a stair



Stair terminology

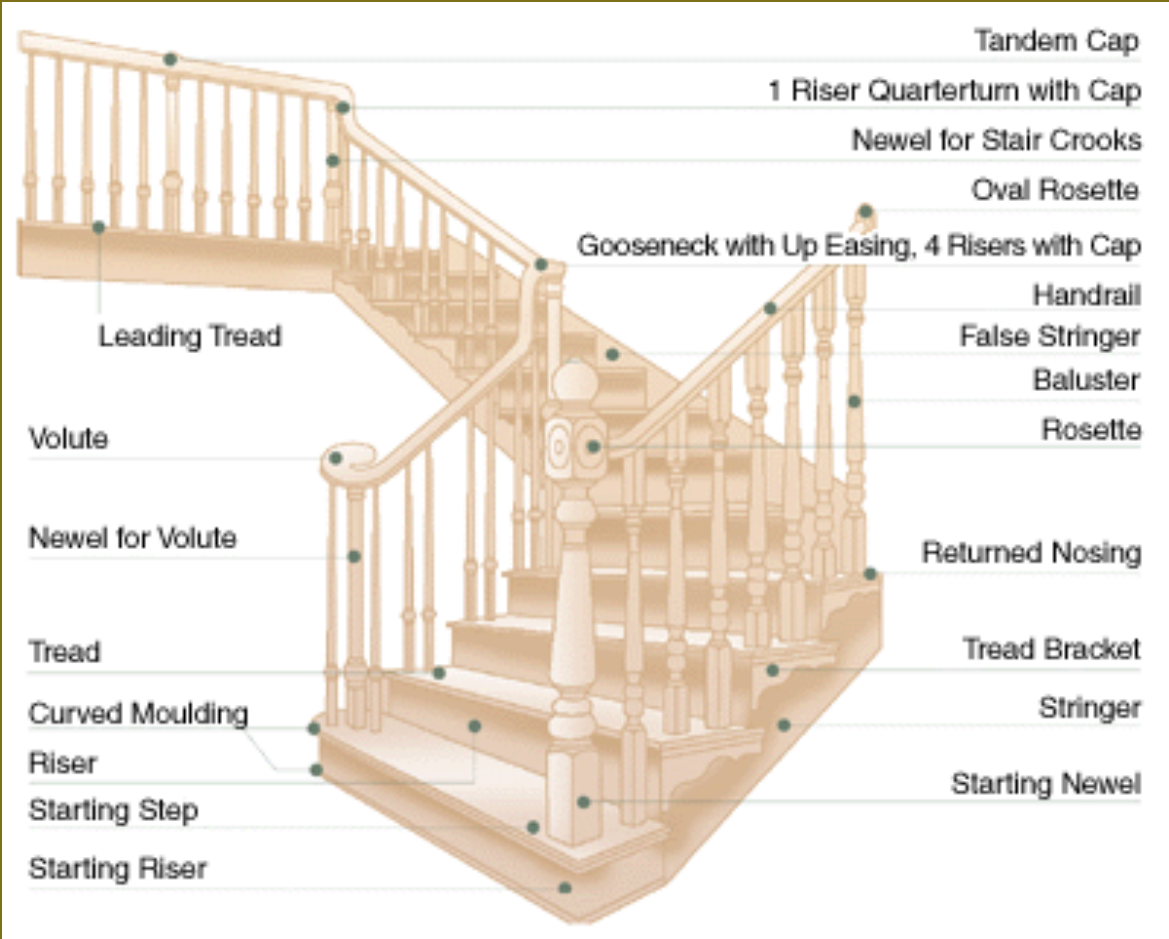

Stair Terminology

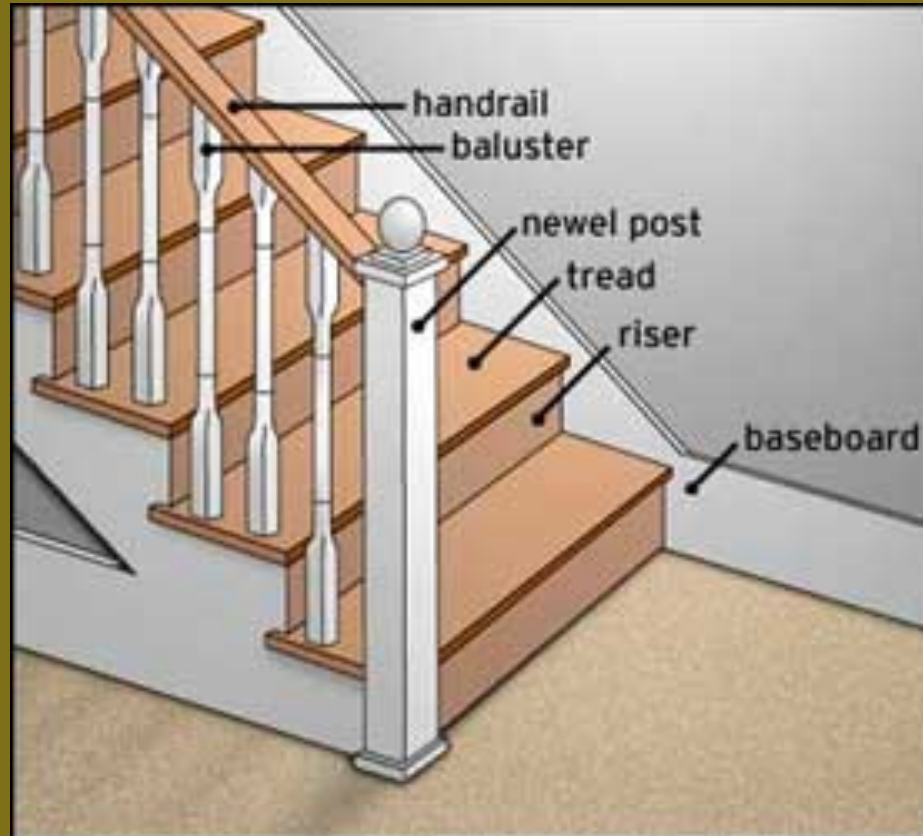

The opening and head clearance to the floor above

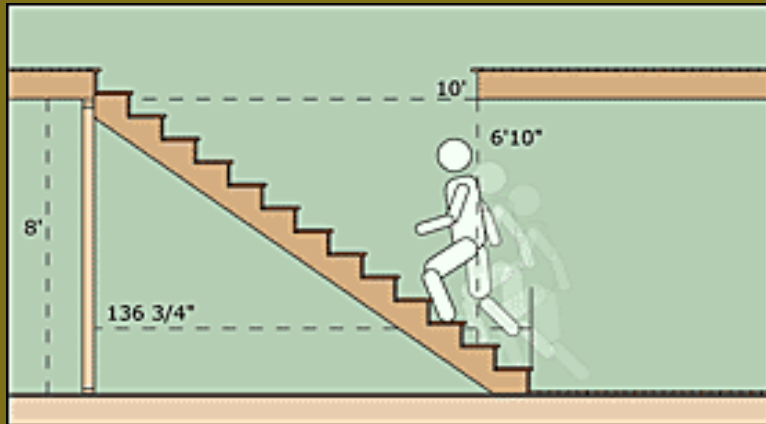
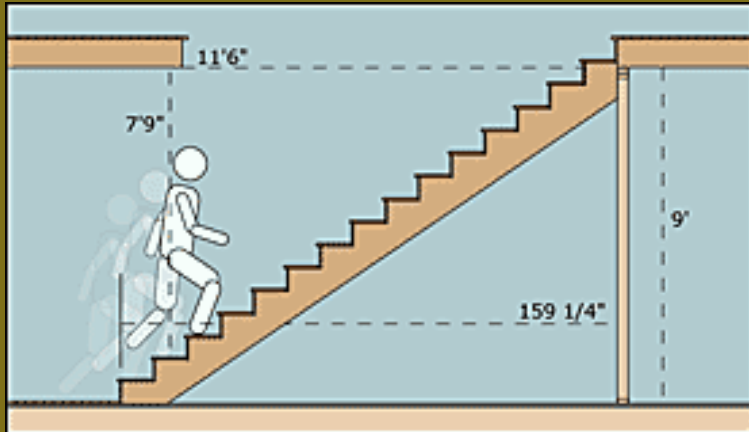

open riser stair

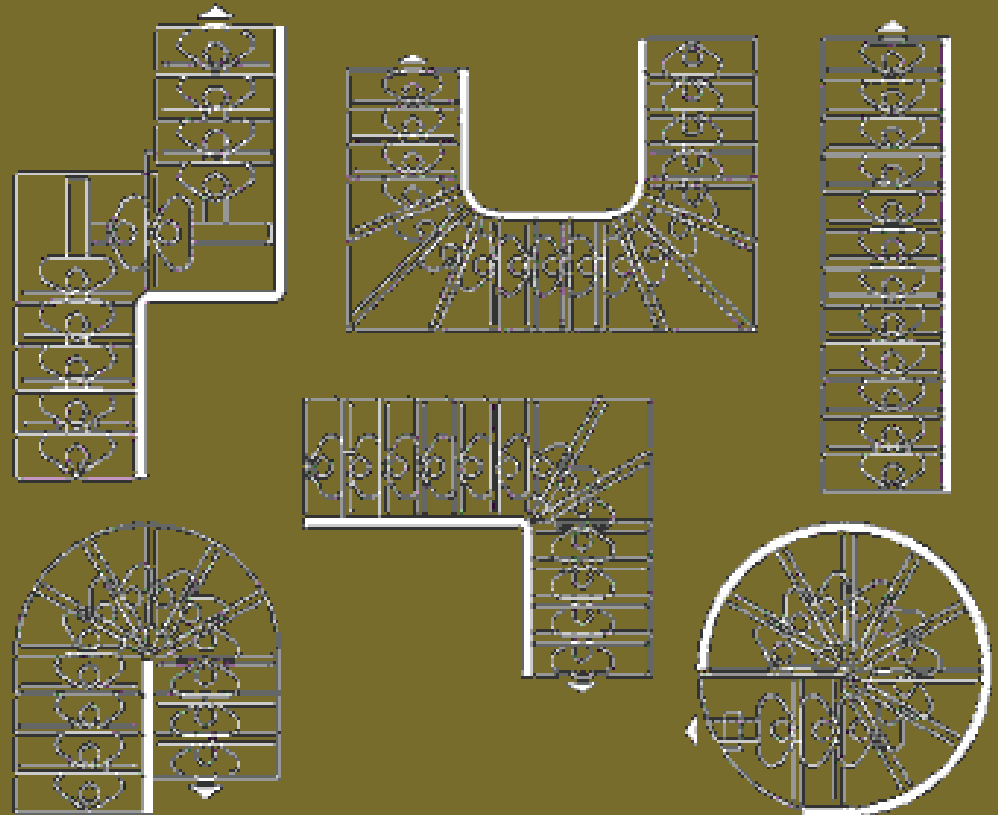

spiral stairs
A CNC plywood spiral stair



Elevators: hydraulic

How Hydraulic Elevators work

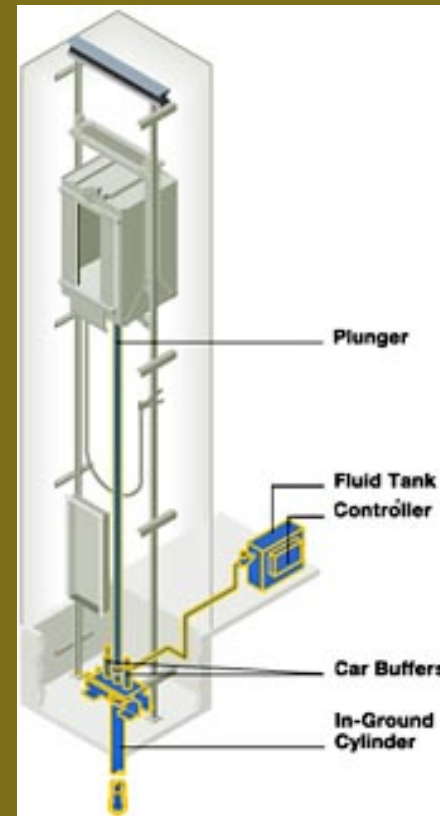
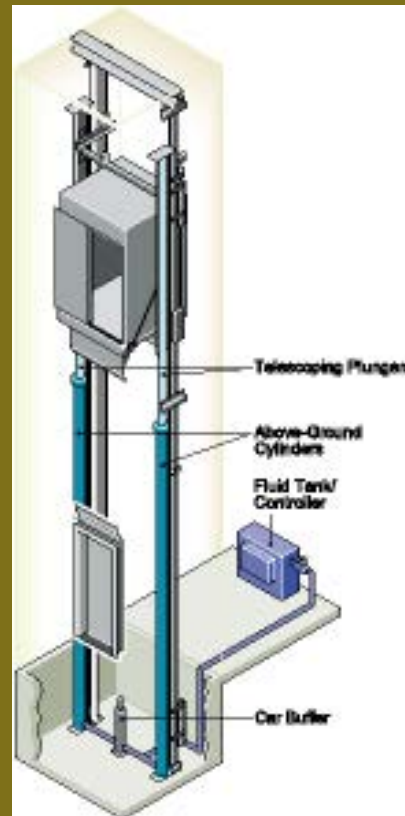
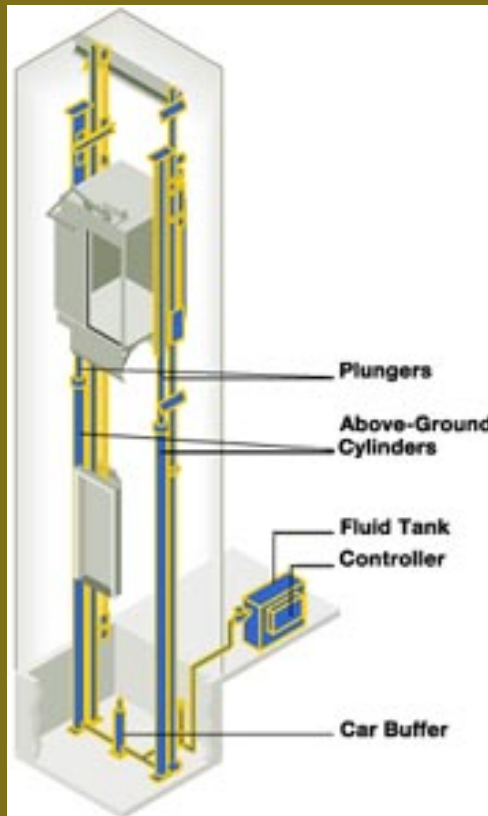

the components in a hydraulic elevator

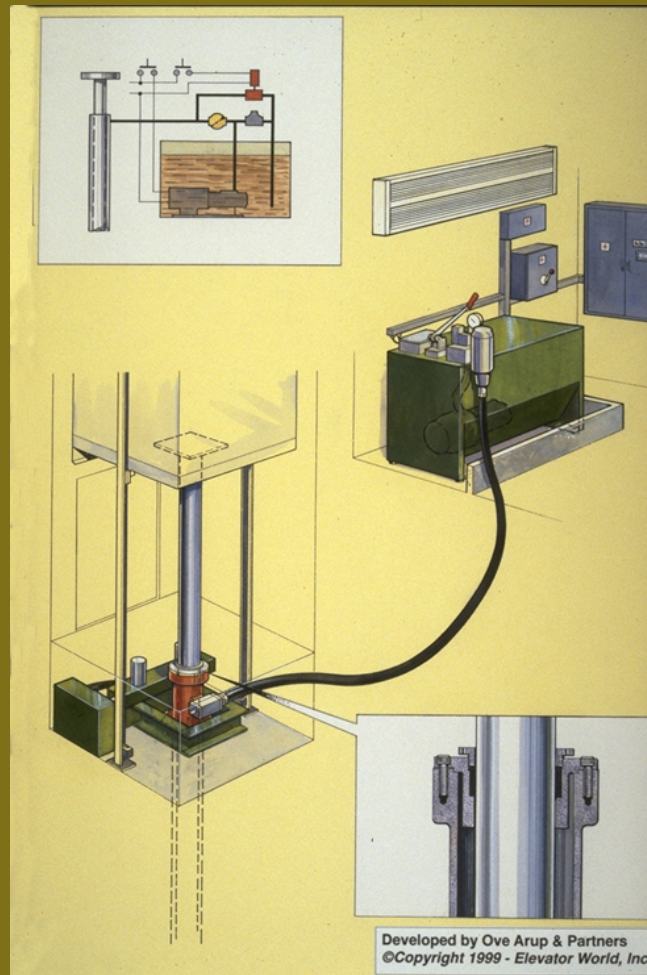
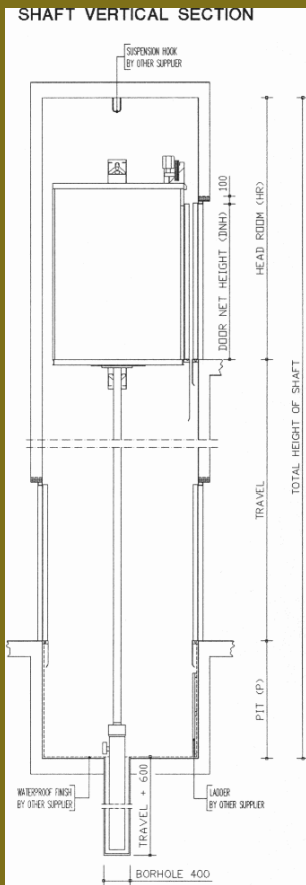

Elevators: geared traction

- How Elevators Work

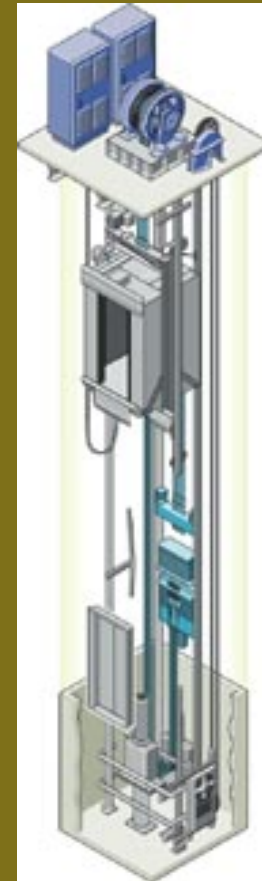

Elisha Graves Otis

- Perched on a hoisting platform high above the crowd at New York's Crystal Palace, a pragmatic mechanic shocked the crowd when he dramatically cut the only rope suspending the platform on which he was standing.
- The platform dropped a few inches, but then came to a stop. His revolutionary new safety brake had worked, stopping the platform from crashing to the ground. "All safe, gentlemen!" the man proclaimed.

Mr. Otis demonstrating the safety of his elevators

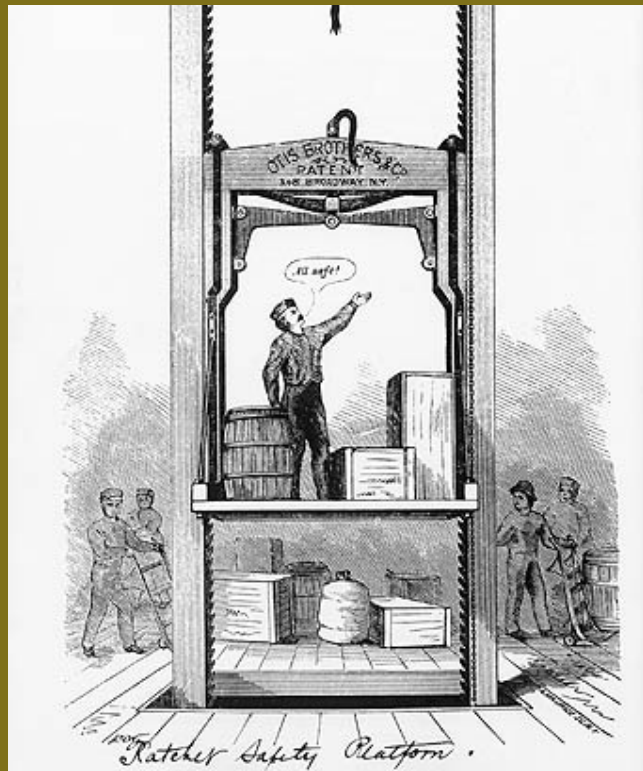

Otis elevator company, 1853

- The man riding the hoist was Elisha Graves Otis, the founder and namesake of our company. With his safety brake, Otis literally started the elevator industry.
- His invention enabled buildings – and architects’ imaginations – to climb ever skyward, giving a new and bolder shape to the modern urban skyline.

Mr. Otis sold his first safe elevators in 1853.

- elevators are described by their
 - **carrying capacity**
 - **speed of travel**
 - **mechanical type**
- Otis Geared Elevonic, 3500, 300fpm

Lloyd's of London

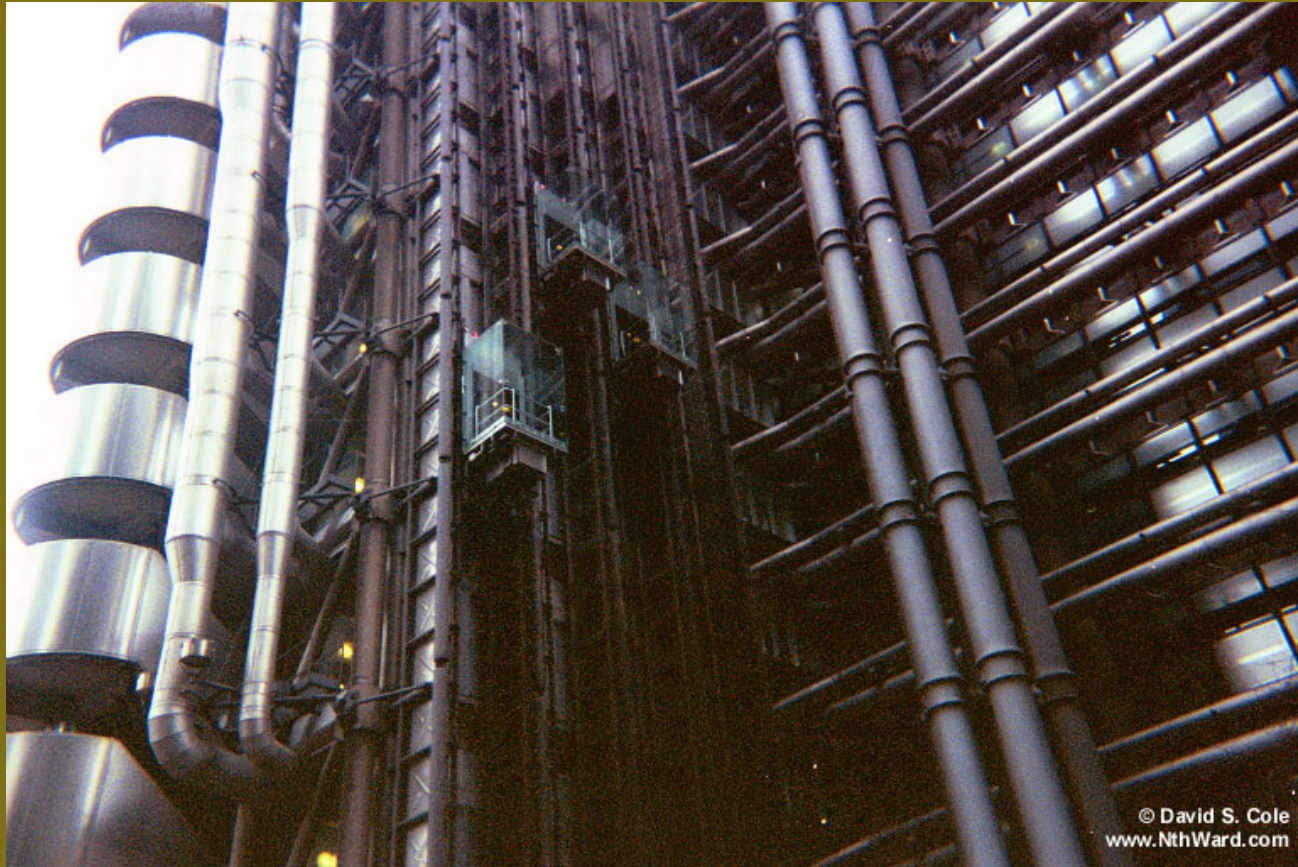

Elevators are mini rooms!



elevator scheme for a high rise building

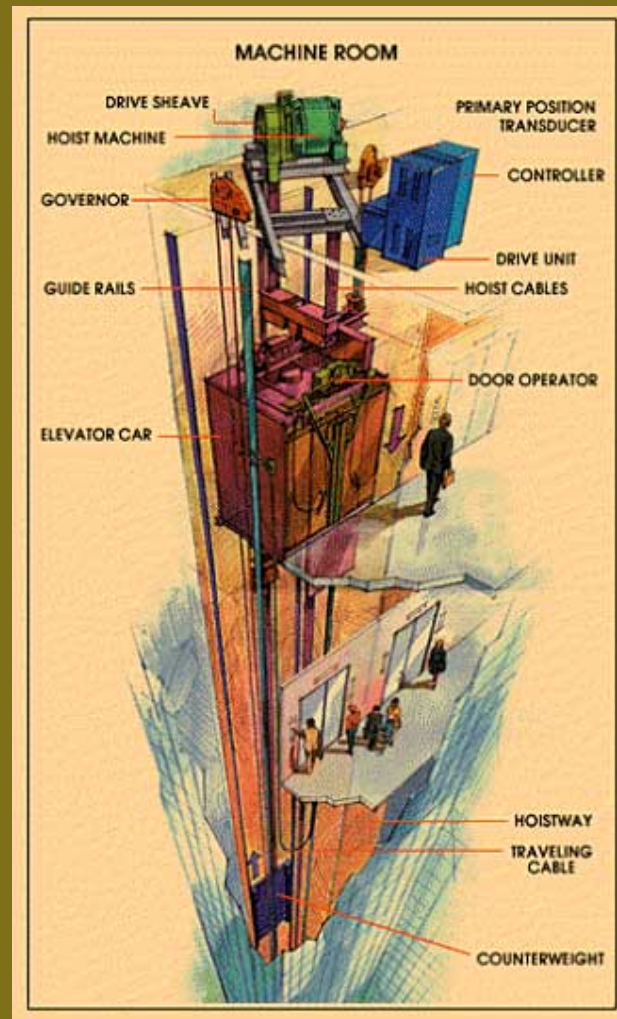

elevators in public buildings are required to meet ADA (Americans with Disabilities) accessibility codes

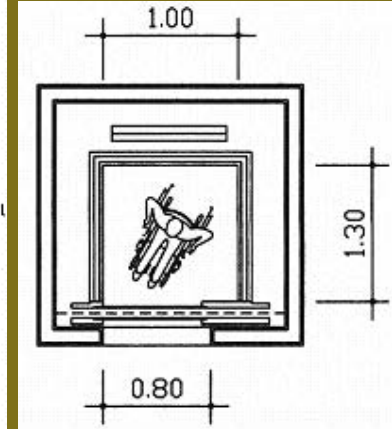
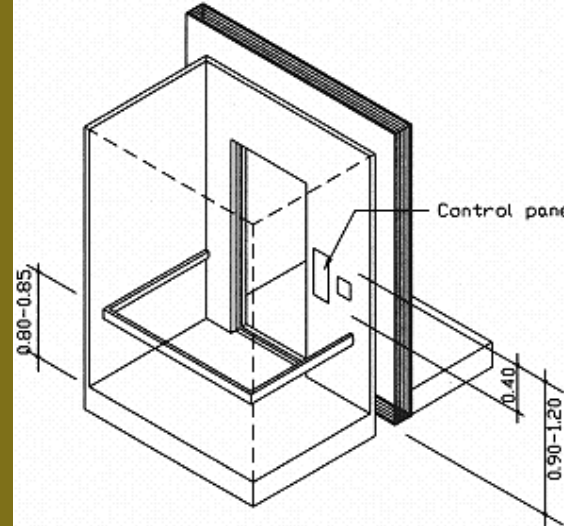

elevators in open atrium spaces:
mechanical components are visible

